

Multi-Function Transmitter for Pressure-Temperature with an external Temperature Sensor

TPSE

Main features

- Pressure measuring ranges 0...4 bar to 0...600 bar
- Temperature measuring range -50°C to +200°C
- Output signals for pressure 4...20 mA, 0...10 V
for temperature 4...20 mA
- No internal transmission media
- Highly reliable
- Protection class IP67



Applications

- Hydraulics
- Pneumatics
- Air conditioning and refrigeration (HVAC) heating systems
- Plant and automation engineering

Description

This intelligent solution combines **two transmitters** which are capable of measuring **pressure** and **temperature** at the same time and **independently**.

The TPSE has excellent characteristics for its stainless steel membrane and semi-conductor thin-film technology. The stainless steel membrane is absolutely vacuum-tight, extremely burst-proof and applicable with all standard media used in hydraulics, pneumatics, etc. as far as they are compatible with stainless steel. Its robust design guarantees high reliability also in rugged environments.

Installing an external temperature sensor will enable quick adjustment times, with custom-made length of the temperature sensor to be installed.

Specification

Pressure range						
Measuring range*	p [bar]	4	6	10	40	60
Overload pressure	p [bar]	20	20	20	200	200
Burst pressure	p [bar]	30	30	30	300	300
Measuring range*	p [bar]	100	400	600		
Overload pressure	p [bar]	200	840	840		
Burst pressure	p [bar]	300	1050	1050		
Electrical parameter						
		signal for pressure		U_s [V _{DC}]	R_i [k Ω]	R_A [Ω]
Output signal * and maximum acceptable burden R_A	R_A in Ohm	4...20 mA	(2-wire, 3-wire)	9...32	acc. to $R_A = (U_s - 10V) / 0,02 A$	
		0...10 V _{DC}	(3-wire)	12...32	> 5,0	
		signal for temperature				
		4...20 mA	(2-wire)	9...32		
Response time * (10-90%)		for pressure		for temperature		
	t [ms]	< 1		10-20		
Withstand voltage	U [V _{DC}]	350				
Accuracy		pressure/temperature				
Accuracy @RT	% of the range	$\leq 0,50^{**}$	option $\leq 0,25$ (only valid for pressure)			
	BFSL	$\leq 0,125$				
Non-linearity	% of the range	$\leq 0,15$	** incl. nonlinearity, hysteresis, repeatability, zero-offset- and final-offset			
Repeatability	% of the range	$\leq 0,10$	(acc. to IEC 61298-2)			
Stability/year	% of the range	$\leq 0,10$				
Acceptable temperature ranges		pressure/temperature				
Measuring medium, always	T [°C]	-40...125				
Measuring medium, 15 min	T [°C]	-50...200				
Ambience	T [°C]	-40...105				
Storage	T [°C]	-40...125				
Compensated range*	T [°C]	-20...85				
Temperature coefficient within the compensated range						
Mean TC offset	% of the range	$\leq 0,15 / 10K$				
Mean TC range	% of the range	$\leq 0,15 / 10K$				
Total error	% of the range	-40°C	2,00%			
	% of the range	105°C	2,00%			
Mechanical parameter						
Parts in contact with the measuring medium*	stainless steel					
Housing*	stainless steel					
Shock resistance	g	1000	nach IEC 68-2-32			
Shock resistance	g	1000	acc. to IEC 68-2-32			
Vibration resistance	g	20	acc. to IEC 68-2-6 and IEC 68-2-36			
Mass	m [g]	> 120	depending on design			
CE - conformity	EC Directive 89/336/EWG					
IP system of protection	The IP system of protection as specified in the data sheets generally applies, with their mating plug connected. Relative pressure transmitters usually require a ventilated mating plug and/or cable to allow for pressure compensation. From a pressure range of 60 bar, a ventilated mating plug and/or cable is					
* others upon request	not necessarily required.					

Configuration

TPSE with M16x0,75 (S723)

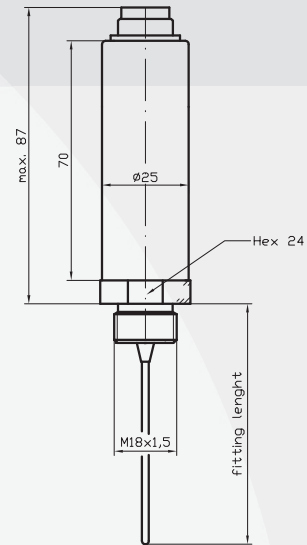

Connectors*

male socket
M12x1
(S 763)

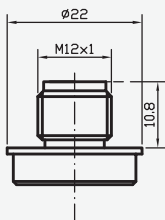

male socket
M16x0,75
(S 7 23)

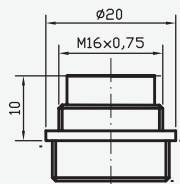

cable output
plastic

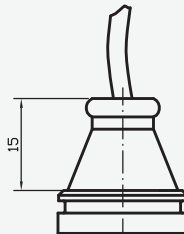

Pressure Connections*

G 1/2 A;
DIN 3852; Form E

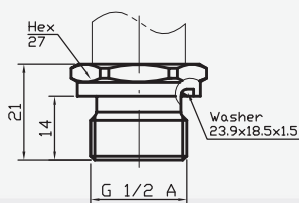

G 1/4 A;
DIN 3852; Form E

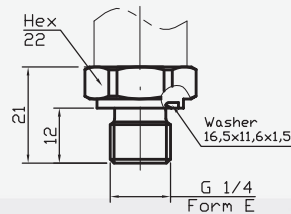

M18x1,5

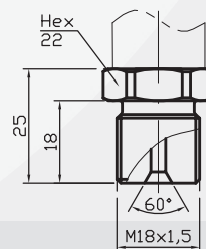

* custom-made adjustments acc. to pressure connections and connecting options are possible

TPSE

Multi-Function Transmitter for Pressure-Temperature with an external Temperature Sensor

Electrical Connections* (left: 2-wire, right: 3-wire)

male socket M16x0,75 (S 723, 5 pin)

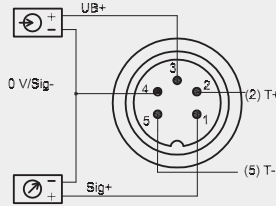
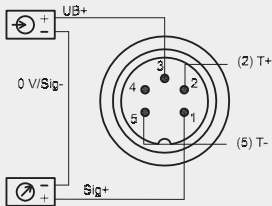

male socket M16x0,75 (S 723, 8 pin)

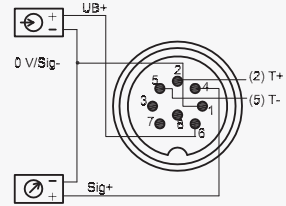
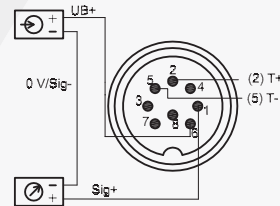

male socket M12x1 (S 763, 5 pin)

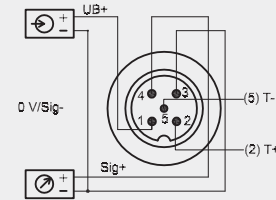
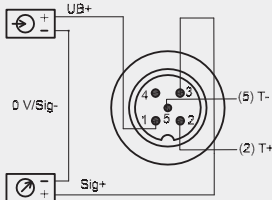

cable output

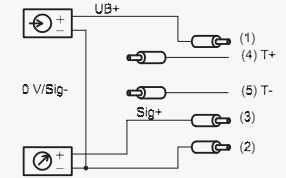
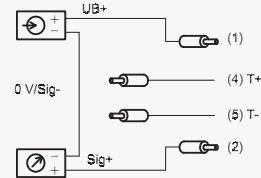

Legend

= power supply
 = load

- (1) red
- (2) black
- (3) white
- (4) green
- (5) white / blue

* custom-made adjustments acc. to pressure connections and connecting options are possible

Product line

DS4	Electronic Pressure Switch	SMC	Pressure Transmitter with CANopen Interface
DPSX9I	Intrinsically Safe Electronic Pressure Switch for Current	SME	Pressure Transmitter in Miniature Design
DPSX9U	Intrinsically Safe Electronic Pressure Switch for Voltage	SMF	Pressure Transmitter with Flush Diaphragm
PS1	Level Sensor	SMH	High Pressure Transmitter
PSX2	Intrinsically Safe Level Sensor	SML	Pressure Transmitter for Industrial Application
SHP	High Precision Pressure Transmitter	SMO	Pressure Transmitter in Mobile Hydraulics
SIS	Low Pressure Transmitter in Short and Compact Design	SMS	OEM Pressure Transmitter for Hydraulics and Pneumatics
SIL	Low Pressure Transmitter for Industrial Application	SMX/SMX2	Intrinsically Safe Pressure Transmitter for Industrial Application
SKE	High Temperature Pressure Transmitter with Detached Electronics	TPS	Multi-Function Transmitter for Pressure and Temperature
SKL	High Temperature Pressure Transmitter with Cooling Fins		



MEGATRON, s.r.o.

Mrštíkova 16 • 100 00 Praha 10
Tel.: 274 780 972 • Fax: 274 780 975

E-mail: info@megatron.cz
www.megatron.cz