

# Low Pressure Transmitter for Industrial Applications

S I L

## Main features

- Measuring ranges 0...10 mbar to 0...40 bar
- Standard signals 4...20 mA, 0...10 V, 1...5 V
- Highly flexible options by its modular design
- Highly reliable

## Applications

- General industrial use
- Hydraulics
- Pneumatics
- Mechanical engineering
- Plant engineering and automation technology

## Description

The Si-based pressure sensors which in their external design are comparable to the SML model can make use of the advantages of silicon technology. These benefits include lower overall production costs. Thanks to its design, all customary and client-specific pressure connection configurations are possible. Also, the complete range of electrical adapters, which are already known from the SML series, can be integrated.

Its modular design permits reasonable manufacture also in medium-size batches that can be supplied within short periods of time.

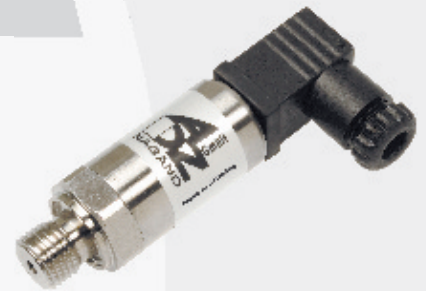
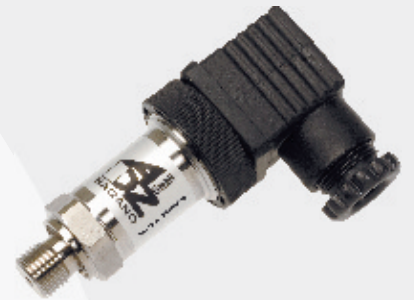

### Specifications

<b>Pressure range</b>								
Measuring range*	p [mbar]	10	16	20	25	40	60	100
Overload pressure	p [mbar]	300	300	300	300	300	300	300
Burst pressure	p [mbar]	500	500	500	500	500	500	500
Measuring range*	p [mbar]	160	200	250	400	600	1000	
Overload pressure	p [mbar]	300	300	2000	2000	2000	2000	
Burst pressure	p [mbar]	500	500	3000	3000	3000	3000	
Measuring range*	p [bar]	1,6	2,0	2,5	4,0	6,0	10,0	
Overload pressure	p [bar]	6	6	6	10	20	20	
Burst pressure	p [bar]	9	9	9	15	30	30	
Measuring range*	p [bar]	16	20	25	40			
Overload pressure	p [bar]	40	40	100	100	(vacuum, relative pressure, + -		
Burst pressure	p [bar]	60	60	150	150	or absolute pressure are available)		
<b>Electrical parameter</b>								
Output signal * and maximum acceptable burden $R_A$	$R_A$ in Ohm	signal			$U_s$ [V <sub>DC</sub> ]	$R_L$ [k $\Omega$ ]	RA [ $\Omega$ ]	
		4...20 mA	(2-wire, 3-wire)		9...32		acc. to $R_A = (U_s - 10V) / 0,02 A$	
		0...10 V <sub>DC</sub>	(3-wire)		12...32	> 5,0		
		1...5 V <sub>DC</sub>			8...32	> 1,0		
		0,5...4,5 V <sub>DC</sub>	ratiometric		5 $\pm$ 10%	> 4,7		
Response time * (10-90%)	t [ms]	< 1						
Withstand voltage	U [V <sub>DC</sub> ]	350						
<b>Accuracy</b>								
Accuracy @RT	% of the range	$\leq 1,0^{**}$	Option $\leq 0,5$		** incl. nonlinearity, hysteresis, repeatability, zero-offset- and final-offset (acc. to IEC 61298-2)			
	BFSL	$\leq 0,25$						
Non-linearity	% of the range	$\leq 0,15$						
Repeatability	% of the range	$\leq 0,10$						
Stability/year	% of the range	$\leq 0,10$						
<b>Acceptable temperature ranges</b>								
Measuring medium	T [°C]	-40...85						
Ambience	T [°C]	-40...85						
Storage	T [°C]	-40...85						
Compensated range*	T [°C]	-10...70						
<b>Temperature coefficient within the compensated range</b>								
Mean TC offset	% of the range	$\leq 0,15 / 10K$						
Mean TC range	% of the range	$\leq 0,15 / 10K$						
Total error	% of the range	-40°C	3,00%					
	% of the range	85°C	3,00%					
<b>Mechanical parameter</b>								
Parts in contact with the measuring medium*		silicon						
Housing*		stainless steel						
Shock resistance	g	1000	acc. to IEC 68-2-32					
Vibration resistance	g	20	acc. to IEC 68-2-6 and IEC 68-2-36					
Mass	m [g]	80-120	depending on design					
CE - conformity		EC Directive 89/336/EWG						
IP system of protection		The IP system of protection as specified in the data sheets generally applies, with their mating plug connected. Relative pressure transmitters usually require a ventilated mating plug and/or cable to allow for pressure compensation. From a pressure range of 60bar, a ventilated mating plug and/or cable is not necessarily required.						
* other upon request								

Configurations -examples-

SIL with MVS/C connector

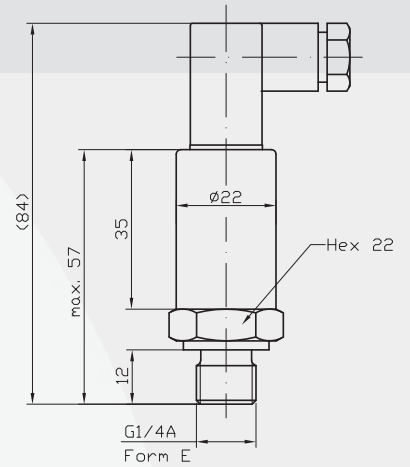
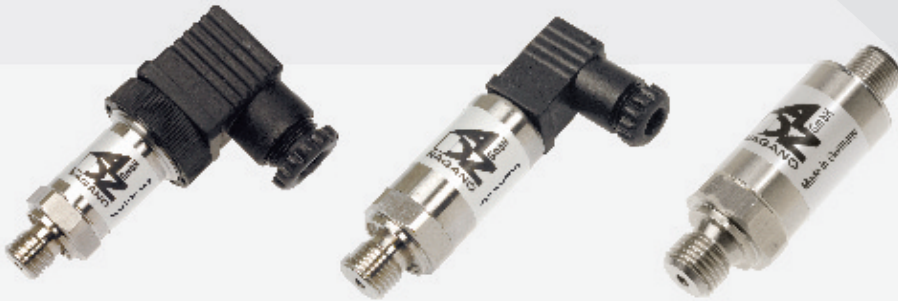

(deviations for absolute pressure are possible)

Connectors\*

male socket  
M12x1 (S 763)

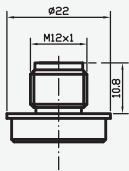

cable output

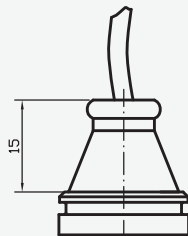

MVS/A  
DIN EN 175301-803

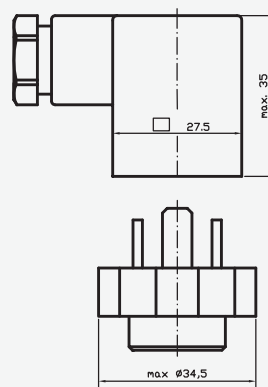

MVS/C  
DIN EN 175301-803

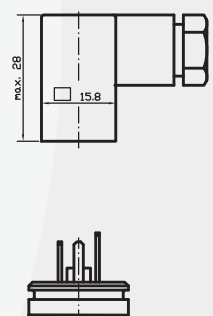

Pressure Connections\*

G 1/4 A; DIN 3852; Form E

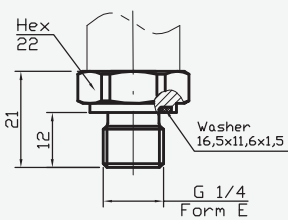

G 1/4 B

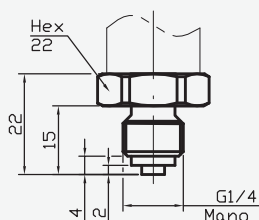

G 1/2 B

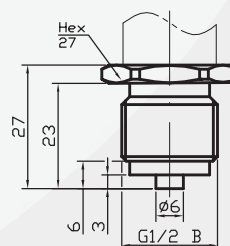

1/4 NPT

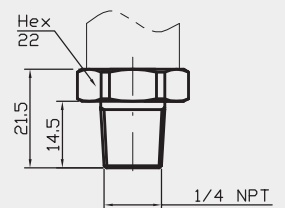

\* custom-made adjustments acc. to pressure connections and connecting options are possible

# SIL

Low Pressure Transmitter  
for Industrial Applications

## Electrical Connections\* (left: 2-wire, right: 3-wire)

MVS/A  
DIN EN  
175301-803

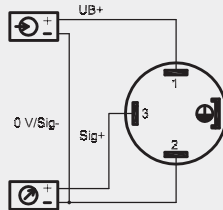
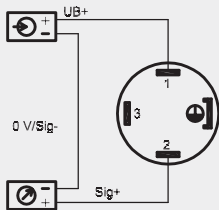

male  
socket  
M12x1  
(S 763)

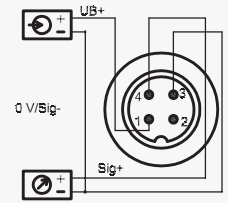
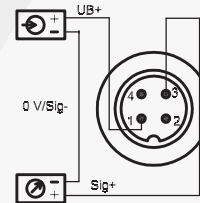

MVS/C  
DIN EN  
175301-803

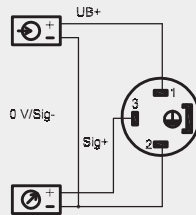
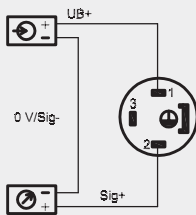

cable  
output

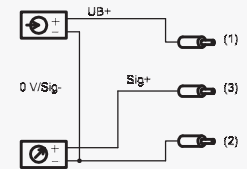
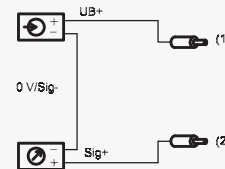

### Legend

power supply  
 consumer

red  
 black  
 white

\* custom-made adjustments acc. to pressure connections and connecting options are possible

### Product line

DS4	Electronic Pressure Switch	SMC	Pressure Transmitter with CANopen Interface
DPSX9I	Intrinsically Safe Electronic Pressure Switch for Current	SME	Pressure Transmitter in Miniature Design
DPSX9U	Intrinsically Safe Electronic Pressure Switch for Voltage	SMF	Pressure Transmitter with Flush Diaphragm
PS1	Level Sensor	SMH	High Pressure Transmitter
PSX2	Intrinsically Safe Level Sensor	SML	Pressure Transmitter for Industrial Application
SHP	High Precision Pressure Transmitter	SMO	Pressure Transmitter in Mobile Hydraulics
SIS	Low Pressure Transmitter in Short and Compact Design	SMS	OEM Pressure Transmitter for Hydraulics and Pneumatics
SIL	Low Pressure Transmitter for Industrial Application	SMX	Intrinsically Safe Pressure Transmitter for Industrial Application
SKE	High Temperature Pressure Transmitter with Detached Electronics	TPS	Multi-Function Transmitter for Pressure and Temperature
SKL	High Temperature Pressure Transmitter with Cooling Fins		



**MEGATRON, s.r.o.**

Mrštíkova 16 • 100 00 Praha 10  
Tel.: 274 780 972 • Fax: 274 780 975

E-mail: [info@megatron.cz](mailto:info@megatron.cz)  
[www.megatron.cz](http://www.megatron.cz)