

## Series MOT13 / Optoelectronic Encoder

- Housing  $\varnothing$  13 mm
- 100-16000 ppr
- 2 Channel and Index
- TTL , Open Collector or Line driver Output
- Supply Voltage 5 V
- Ball bearing

In spite of its small housing  $\varnothing$ 13 mm the MOT13 generates a high resolution up to 16000 ppr. Typically it is used for robots in the medical industry and medical devices.

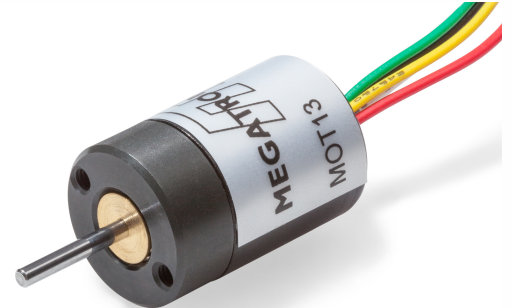

## Drawing

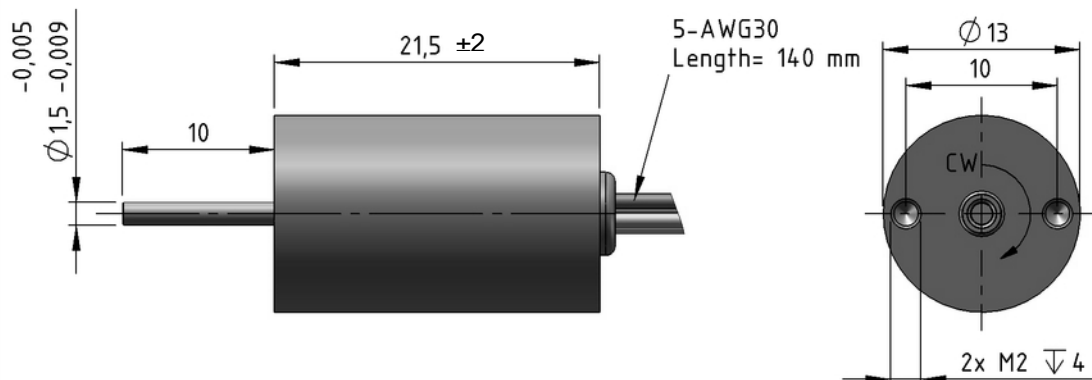

1:1

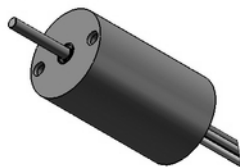

### Cable assignment

Open Collector and Voltage output	
red	VSUP +5 V
black	0 V
white	Channel A
green	Channel B
yellow	Channel Z

### Linedriver

red	VSUP +5 V
black	0 V
white	Channel A
green	Channel B
yellow	Channel Z
brown	Channel /A
blue	Channel /B
orange	Channel /Z

# Series MOT13 / Optoelectronic Encoder

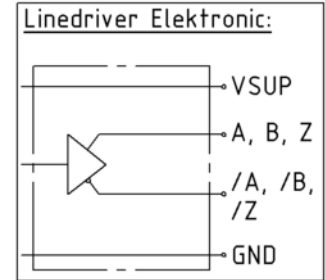
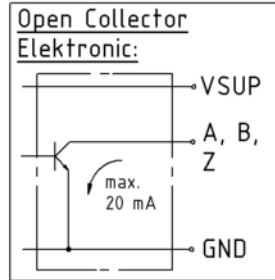
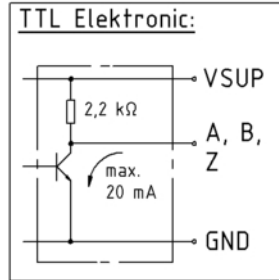
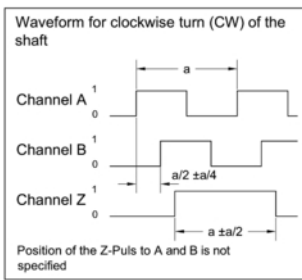

Electrical Data	TTL-Output	Open Collector Output	Line driver Output
Resolution [ppr]	100, 200, 256, 300, 360, 500, 1000, 1024	100, 200, 256, 300, 360, 500, 1000, 1024, 2000, 4000, 8000, 16000	
Output Channel	A, B, Z		
Limit frequency	100 kHz		
Supply Voltage	5 VDC ± 0,1 V		
Supply Current (no load)	< 40 mA		
Output Voltage Low	≤ 0,5 V; IOL = +10mA; V <sub>PullUp</sub> = 5 VDC		Application as sink is not possible
Max. Output Current	IOL = +4 mA		Application as sink is not possible

Mechanical Data	
Max. rotational speed	6000 rpm
Max. radial load	1 N
Max. axial load	1 N

# Series MOT13 / Optoelectronic Encoder

## Other Data

Protection	IP40
Operating temperature	0.. +60° C
Storage temperature	-20 .. +80° C
Shock resistance	500 m/s <sup>2</sup> (approx. 50 g) 3 times each in X,Y und Z
Vibration resistance	55 Hz, 1,5mm p2p, 2 hours in X,Y und Z
Humidity	35%....90% RH (no dewing)
Bearing	Ball bearing
Weight	5 g

## Options and Ordercode

Series MOT13	MOT13				
<u>Resolution [Pulses per revolution]</u>					
		100 (*)			
		200 (*)			
		256 (*)			
		300 (*)			
		300 (*)			
		<b>360</b>			<b>TTL</b>
		500 (*)			
		1000 (*)			
		1024 (*)			
		2000 (*)			
		<b>4000</b>			<b>K</b>
		8000 (*)			
		16000 (*)			
<u>Supply voltage</u>					
5 VDC (linedriver)			5		
2 channels with index				BZ	
<u>Electronics:</u>					
TTL					TTL (*)
Open Collector					K (*)
Line Driver					N (*)

(\*) = on request available for projects

27.09.2016 All specifications are subject to change without notice